

MICRODIS



COMPETENCE & RELIABILITY

Leading in Eastern Europe as

- **Technical broadline distributor of electronic components**
- **Logistic and service provider**
- **Always reliable business partner**



GROUP STRATEGY

Pan East European sales network

Local & professional support

- Microdis companies located across Eastern Europe
- Over 30 years of experience and built up trust on the market



MICRODIS BUSINESS MODEL

Sales strategy



Technical distribution

Franchise distribution of selected manufacturers
Competent application & design-in support
Extensively trained Application Engineers

One stop shop

Comprehensive portfolio with millions of components
Reliable source for mass production,
as well as for few pieces prototyping and R&D

MICRODIS BUSINESS MODEL

Services

Added value services

- Dedicated web for Epson programming service
- Harness making
- Online ordering and access to components base
- Logistic know-how

Reliability

- AEO and ISO 9001:2015 certificates
- Carefully selected business partners
- Over 30 years of cooperation with customers and suppliers

PRODUCT GROUPS



WIRELESS



E-MECH



EMBEDDED



OPTO & PASSIVE



CRYSTAL DEVICES



HARNESS
MAKING & TOOLS



GNSS RECEIVERS



Wireless

GNSS receivers



u-blox state of the art GNSS receivers

- Benchmark for GNSS performance
- u-blox expertise
 - Own chipsets, algorithms, modules
 - In-depth support
 - Developed for professional market
 - No dependency on external suppliersProduct life cycle under u-blox control (EOL)
- Form factor policy
- Built-in security
- Zero defect strategy
- ISO 16750 qualified modules for in vehicle use, modules produced in Austria (ISO 9001)
- Assisted GNSS service

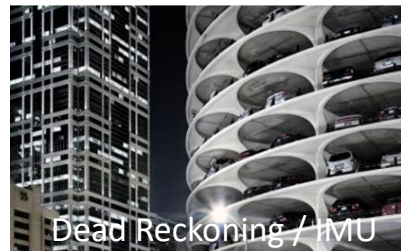

GNSS receivers

Standard Precision



u-blox M8 / M9 / M10 / F10

- Up to 4 GNSS systems used in parallel
- High performance modules for small antennas
- Cost and size efficient portfolio
- High Accuracy: 1m / 1.5m*
- Low Power: 3mW (1Hz)
- Up to 25Hz update rate
- Examples of features:
 - Super-S precision enhancement
 - Spoofing & Jamming protection
 - Odometer, Arm Swing compensation
 - Protection level (95% confidence about the position)
- Same form factors across families and technologies:
 - Standard/High Precision, Dead Reckoning, Timing



ZOE
4.5x4.5x1 mm



MIA
4.5x4.5x1 mm



MAX
10.1x9.7x2.5 mm



NEO
12.2x16mmx2.4 mm



SAM
15.5x15.5x6.3 mm
*Performance optimized
antenna module*



CAM
9.6x14x1.95 mm
*Miniature GNSS with
built-in antenna*



ZED
17.0x22.0x2.4 mm



* dual/single band w/ SBAS, CEP

GNSS receivers

Dead Reckoning



Modules with built-in sensors (IMU)

- Higher precision in urban scenarios with reflections
- Navigation without sky view (tunnel, parking)
- Up to 30Hz position update

UDR - Untethered Dead Reckoning

- plug&play, simple integration

ADR - Automotive Dead Reckoning

- wheel tick over HW pulses or CAN

ADR+RTK – Automotive DR with RTK corrections

- decimetre level accuracy (lane accurate positioning)

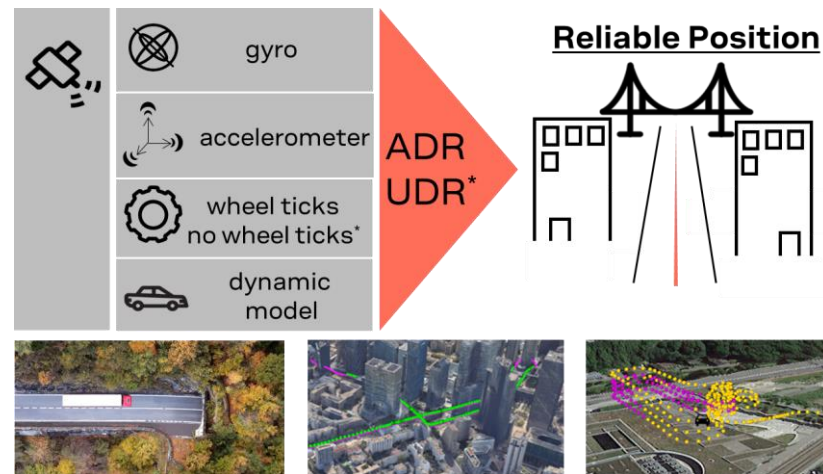

GNSS receivers

High Precision & Timing



High Precision with RTK corrections

- L1/L2, L1/L5 Single and Multi-band receivers
- Position accuracy up to 1cm
- Heading accuracy up to 0.3deg*
- Corrections: local, network, satellite

*baseline length 1.75m



Timing & Frequency receivers

- Time synchronization and measurement
- Nanosecond-level accuracy
- Meets 5G network requirements (2.5ns)
- CVTT (*Common View Time Transfer*)
Differential timing



Telecom



Energy



Finance





CELLULAR AND SATELLITE IOT



Wireless Cellular portfolio

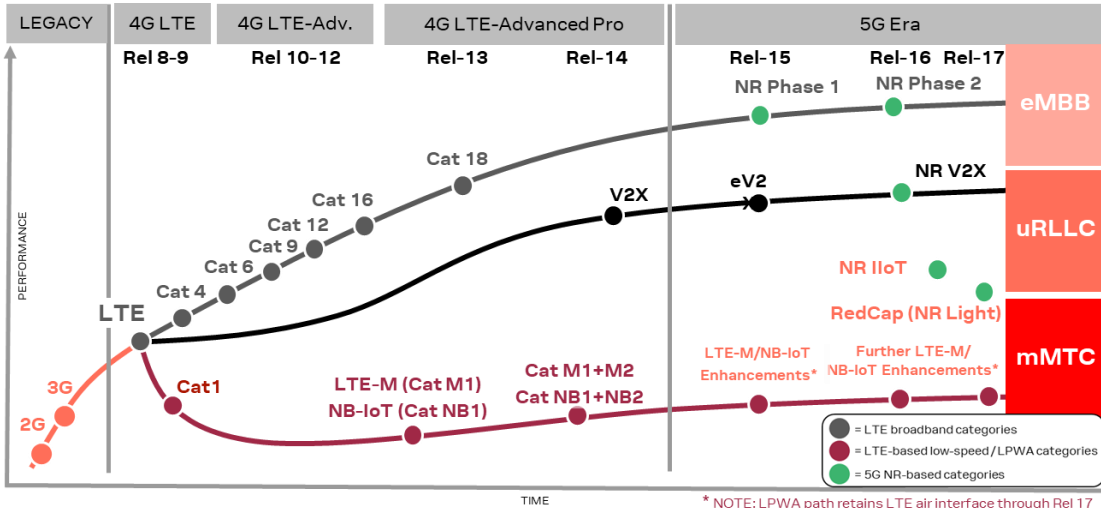

Optimised for IoT market:

- **2G and 3G**
Matured but low price, good coverage
Used mostly in EU, CIS, South America
Data and voice
- **LTE-M, NB-IoT**
New, power & cost optimised LTE standards
Data (voice in the future), 2G fallback
- **LTE Cat.1, LTE Cat.1-bis**
Excellent coverage in place, balanced cost
Data and voice, 2G/3G fallback
Low cost option: Cat.1-bis (one antenna)
- **LTE Cat.4+**
Fast data rates
- **5G – category eMBB introduced**
For high speed data streaming



Wireless Cellular modules



Designed for professional applications

- SARA/LARA/LENA form factor across technologies
- Power, size and cost optimised, reliable modules
 - No compromise in Tx power (23dBm), for coverage
 - ISO 16750 qualified, for in vehicle use
 - u-blox add-on features, for industrial use cases
 - Diagnostic interface and modes
 - Polished utilization of new technologies (network timers, eDRX, RRC Release, etc.), in-depth support
 - Global and local approvals incl. ATEX
 - Zero defect strategy, produced in Austria (ISO 9001)
- u-blox chipset to control the features, life cycle (EOL) and supply chain
- Outstanding security level, secure ecosystem
- Industry's broadest patent infringement protection, declared officially in T&C

2G

LTE NB IoT

LTE-M / NB IoT / 2G,
Satellite IoT

LTE Cat.4 / Cat.1
Cat.1-bis/ 2G / 3G

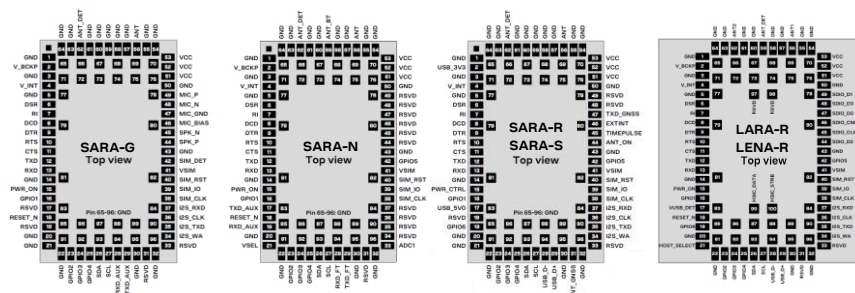



Dual modules: Cellular and GNSS

- Professional approach: separated u-blox chipsets
- Zero compromise
 - The best GNSS performance
 - Additional SAW/LNA for small GNSS antennas
 - Real parallel, independent LTE/GNSS operation
 - LTE at 23dBm Tx level, for coverage
 - Designed for ultra low power

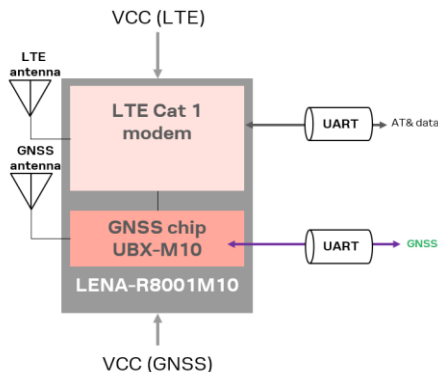

Size optimised, rich in IoT features

- LEXI, 16x16mm form factor
- LTE-M / NB-IoT+2G fallback
- Optimized power management to meet IoT requirements



Wireless

Cellular and Satellite IoT modules



IoT connectivity without coverage issues LTE-M / NB-IoT + Satellite IoT

Satellite communication backup ensures coverage

- Worldwide band coverage LTE-M / NB-IoT
- Satellite connectivity using GEO ORBCOMM's IsatDataPro (IDP) satellite communications protocol
- Embedded u-bloxM10 GNSS positioning chipset
- Small and popular SARA form factor





SHORT RANGE



Short range modules

Stand-alone



Quick development, BT/Wi-Fi stacks built-in short range module

u-connectXpress option

- pre-flashed u-blox u-connectXpress software
- common AT interface across different modules
- stacks integrated by u-blox
- additional features (GATT, SPS etc.)
- Fastest time to market, no software development and testing on customer side

Open CPU option (Wireless CPU)

- Application runs on the u-blox module, based on 3rd party SDK
- Stacks integrated by the customer
- Thread, Matter, Zigbee, Low Energy Mesh support

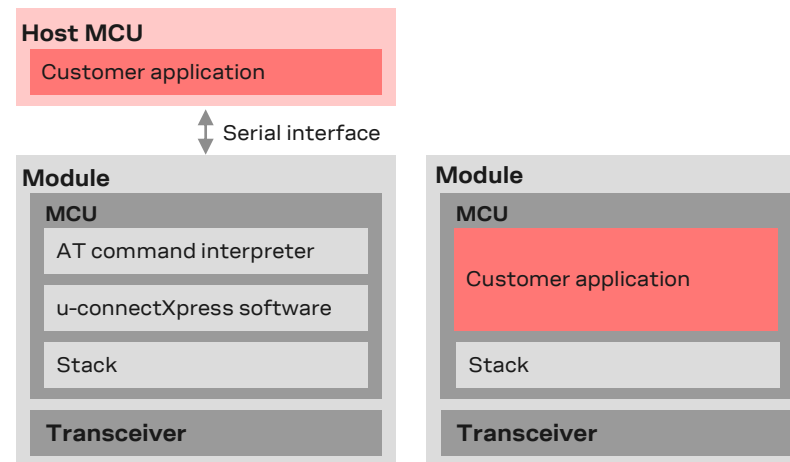

Short range modules

Host-based



For devices with host processor and open OS

Application runs on host processor
3rd party stack runs on host with open OS

Support (drivers) included in SDKs of some MCU suppliers

- MCUXpresso SDK from NXP simplifies integration of host-based modules with popular families of NXP processors (i.MX / iMX RT)

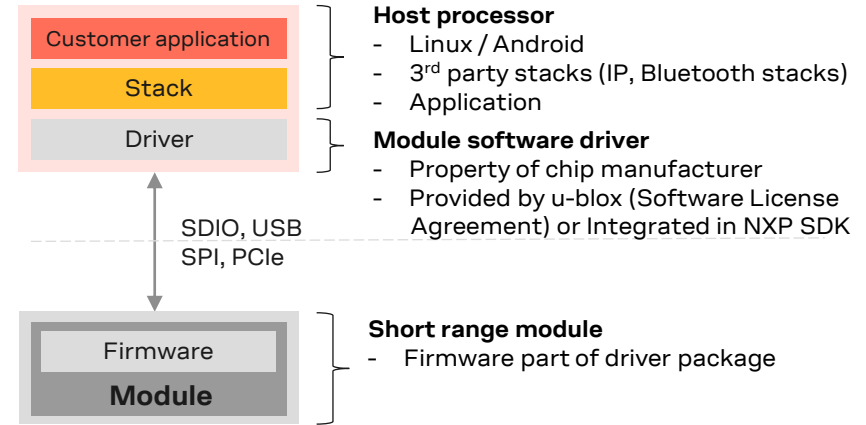

Wireless

Short range modules



Certified, industrial Bluetooth modules

- BT 2.x, BLE 4x & 5.x, also with medical certificates
- Combo with Wi-Fi available
- u-blox u-connectXpress software for easy application design and fast time to market
- Open CPU option for customer application
- Dual core module, one MCU dedicated for application
- NINA form factor for easy multi-solution design
- Dedicated modules for small size (ANNA)
- High density footprints (NORA) for many I/Os
- Various antenna versions, simplified certificates
- AoA/AoD, Mesh, LE Audio, Long range available
- Thread, Matter, Zigbee support

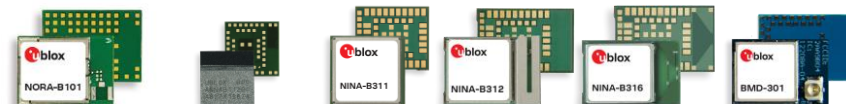
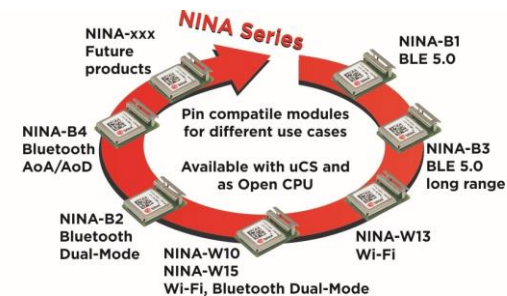

Wireless

Short range modules



Certified, industrial Wi-Fi & Combo modules

- Up to Wi-Fi 6 with WPA3 and Bluetooth 5.x
- Wi-Fi, Bluetooth LE and Classic combo available
- u-blox u-connectXpress software for easy application design and fast time to market
- Open CPU option for customer application
- Various antenna versions, simplified certificates
- NINA form factor for easy multi-solution projects
- Host-based modules for more control and flexibility, with SDIO or USB host interfaces
- Versions dedicated for automotive available
- M.2 WiFi/Bluetooth cards

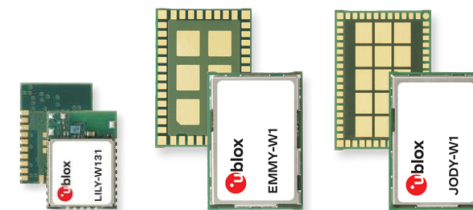
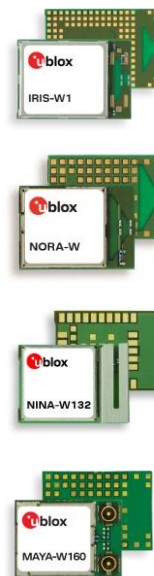



SERVICES

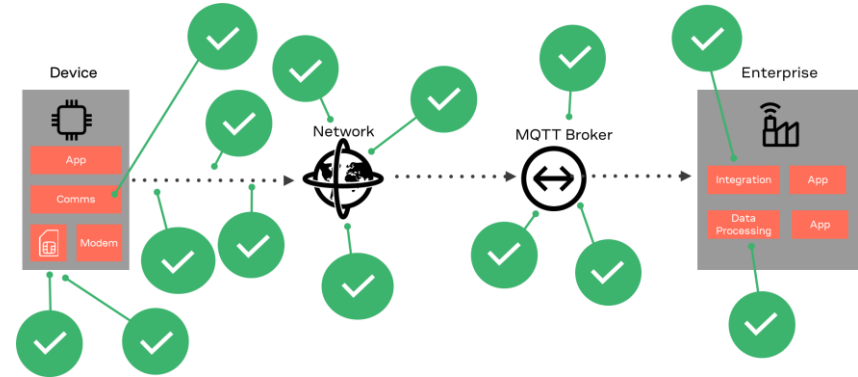



Location

- AssistNOW: data supporting GNSS receivers
- CellLocate: positioning based on cellular network
- PointPerfect: PPP-RTK correction service for high precision navigation
- CloudLocate: cloud based location saving 90% of power

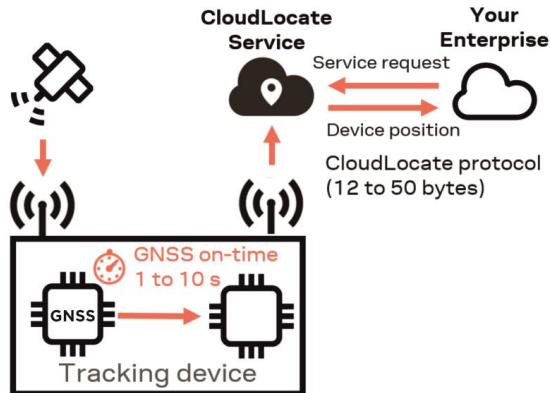

IoT Communication

- Complete connectivity solution for IoT applications
 - SIM, roaming, data transport solution (SDK/libraries)
 - Simple, visual Data Flow Manager
 - u-blox MQTT-SN over USSD or UDP built-in SDK
 - Optimised for low power and low bandwidth
- No hidden costs, pay per MQTT messages
- Seamless integration into Azure, AWS etc.
- Applicable for 2G, 3G, LTE and Wi-Fi devices





Wide selection of products for all wireless applications

- GNSS antennas
 - L1 and multiband (L1, L2, L5)
 - Active and passive
 - External and internal
 - Patented helical antennas from Maxtena
- Cellular antennas, from 2G to 5G (New Radio)
- ISM antennas, for all popular bands
- Various mounting options: patch, magnetic, screw, wall mount, connector mount
- Customisation options





RF Connectors

- All standard connectors: SMA, FME, MCX, MMCX...
- SMD, THT and Edge mount
- Customisable materials and dimensions

SIM Holders



RF Pigtails

- Available with all standard connectors, also in bulkhead versions
- Various coax cable options
- Customisable length, stripping, tinning





RFID





Typical RFID transponders

- 13.56MHz and 125kHz, several chip options
- ISO cards, white or personalized
 - Key fobs
 - Wrist bands



Application specific, reliable solutions

- Transponders, readers, antennas
- Animal Identification
 - Keg & Container
 - Service & Inventory
 - Industry & Logistic
 - Access & Security
 - Individual Solutions

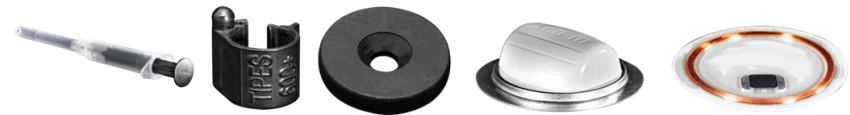

AEG ID



OPTOELECTRONICS, PASSIVE COMPONENTS

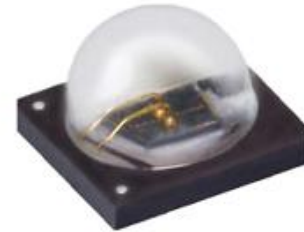

Opto & Passive

LED Diodes



Wide selection of LED diodes for various applications

- 3C Electronics - THT LEDs in various shapes, colours and sizes
- Horticulture dedicated mid and high power LEDs for plant growth stimulation with specific wavelengths
- UV & IR LEDs for special applications. Low, mid and high powers, in various form factors. Wide selection of UV wavelengths (270nm-420nm)
- Lighting Products mid and high power white LEDs in most popular packages (2016, 2835, 3030, 5630, 3535), available also in R, G, B colours
- COBs in standard sizes

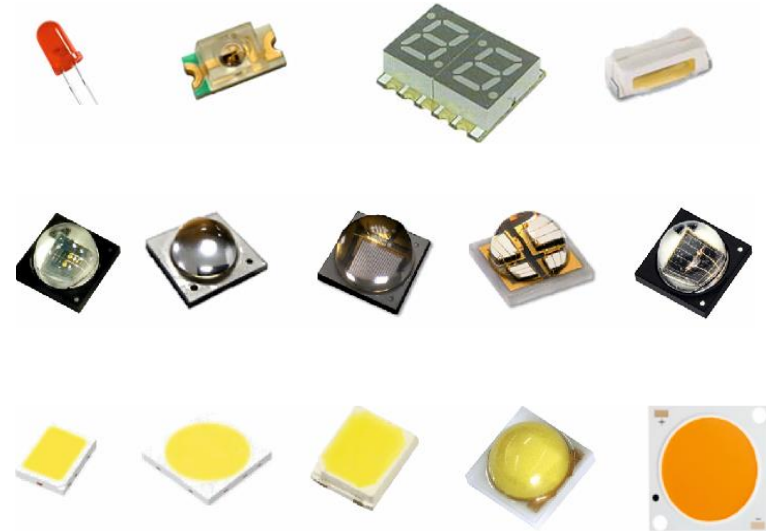

Opto & Passive

Displays and Photo-components



LCD, OLED and TFT displays

- Wide selection of sizes and number of characters
- Monocolour and full colour OLED and TFT displays
- LCD with touch available



Optocouplers, photodiodes/transistors/ interrupters

- Over-under and coplanar types (for better CMR performance)
- DIP and SOP packages

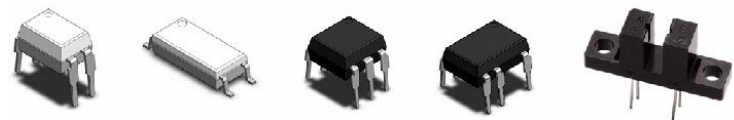



Magnetic components

- Circuit protection, ESD, MOV, GDT
- Inductors: chip, bead, power in THT and SMD Transformers
- Charging coils



• High quality polymer capacitors

- ✓ Provide longer lifetime, voltage stability in different temperatures
- ✓ Low voltage derating
- ✓ Very low bias dependency
- ✓ Capacitors for demanding applications





**CRYSTAL UNITS
OSCILLATORS
RTC MODULES**





Crystal oscillators

- TCXO
- SPXO (kHz & MHz)
- Programmable Oscillators
- VCXO
- SAW Oscillators

Real time clocks

Crystal units

- kHz
- MHz
- SAW Resonators & Filters

X-tal based sensors

- Gyro
- Pressure
- Inertial Measurement Units (IMU)



Crystal devices

Programmable Oscillators



Create your custom SPXO configuration in three easy steps:

- Select a series of products
- Select the package size
- Define electrical parameters

Interactive on-line configurator available now!

Enjoy 24h shipment!

Configure & Buy Crystal Oscillators

MICRODIS
COMPETENCE & RELIABILITY

Seiko Epson European
Programming Partner

epson.microdis.net

epson.microdis.net

EPSON®

Crystal devices

High End Crystal Devices



Defence and instrumentation solutions

- MIL-PRF-3098 Crystal Resonators
- Low noise and low jitter SPXO
- High performance TCXO
- Low noise and low g-sensitivity OCXO
- Ultra low phase noise OCSO & Multipliers

Sub-systems and frequency synthesizers

Hi-reliability products for space

- ESA/SCC 3501, MIL-PRF-3098 qualified Crystal Units
- SPXO, TCXO, VCXO, OCXO oscillators in Hi-Rel Space and New Space spec.
- GPS disciplined oscillators

Ground station solutions



Image: Courtesy of ESA



rakon



ELECTROMECHANICAL

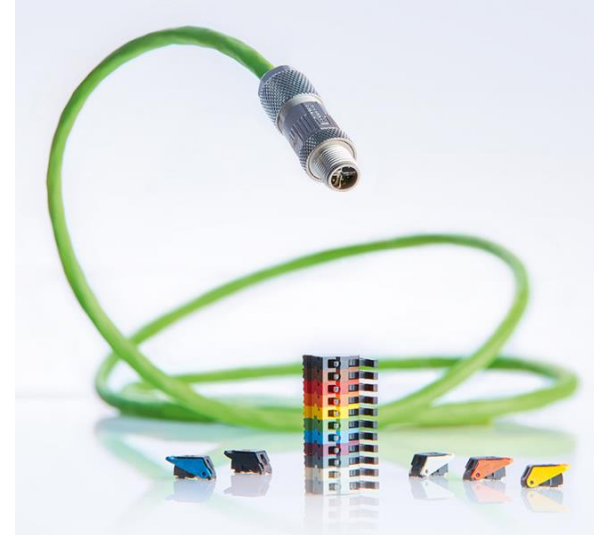

Electromechanical Components

Cabling Solutions for Automotive & Home Appliances



Offering innovation in product and manufacturing technologies

Lear's product portfolio includes standard and custom terminal & connector systems, with capability ranging from signal to high power

Lear main portfolio

- Leaf spring connection systems
- Pin and socket round connection systems
- Secure contact systems
- Flat fuse connection systems

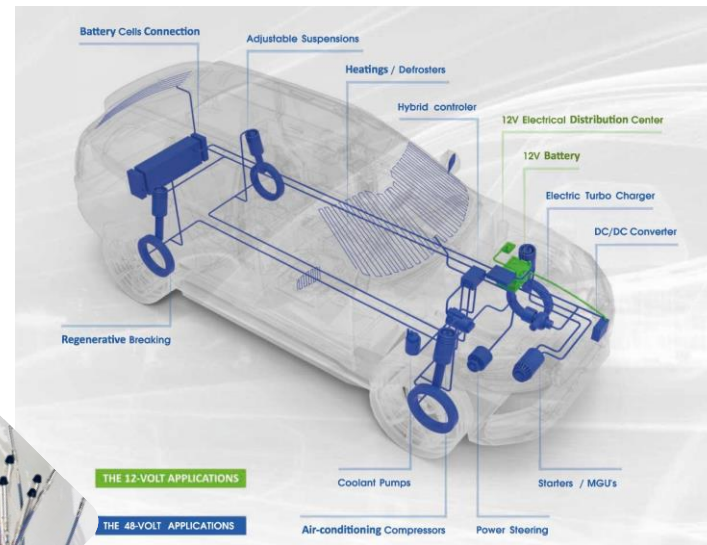

Electromechanical Components

Cabling Solutions for Automotive & Home Appliances



Solderless terminals

- Wire to PCB connectors
 - PCB to PCB connectors
 - Wire to wire connectors
 - Solderless terminals and splices
 - Flat ribbon cables
 - Control cables
 - Stranded wires
- Chain terminals 2.8-4.8-6.3-7.7-9.3mm
 - Tabs & Receptacles
 - Ring tongue and other solderless terminals and splices
 - Customer specific products



JST
The Quality Connection



SAVOY
TECHNOLOGY

Electromechanical Components

Cabling Solutions for Industry, Defence & Medicine



Turning your connectivity challenges into success stories:

- Miniaturization & weight reduction
- Data transmission: more and & faster
- Extreme sealing & hermeticity
- Complete solutions (connectors & cable assemblies)

Choose from more than
30,000 connector configurations



Electromechanical Components

Cabling Solutions for Industry, Defence & Medicine



FISCHER
CORE
SERIES



ANY SIZE
ANY CONFIGURATION
ANY APPLICATION



FISCHER
ULTIMATE™
SERIES



RUGGED
COMPACT
LIGHTWEIGHT



FISCHER
FIBEROPTIC
SERIES



ROBUST
OPTICAL PERFORMANCE
EASY CLEANING



FISCHER
MINIMAX™
SERIES



HIGH-DENSITY MINIATURIZATION
HIGH-SPEED DATA TRANSFER
RELIABILITY



FISCHER
FREEDOM™
SERIES



EASY MATING
EASY CLEANING
EASY INTEGRATION

Electromechanical Components

Cabling Solutions for Industry, Defence & Medicine



Complete solutions, engineering support, rapid delivery

- Vertically integrated solutions (connectors, components, cables and assembly)
- Expertise in design, manufacture & test assemblies
- Fast prototyping & production
- High quality guaranteed in low & high volume projects

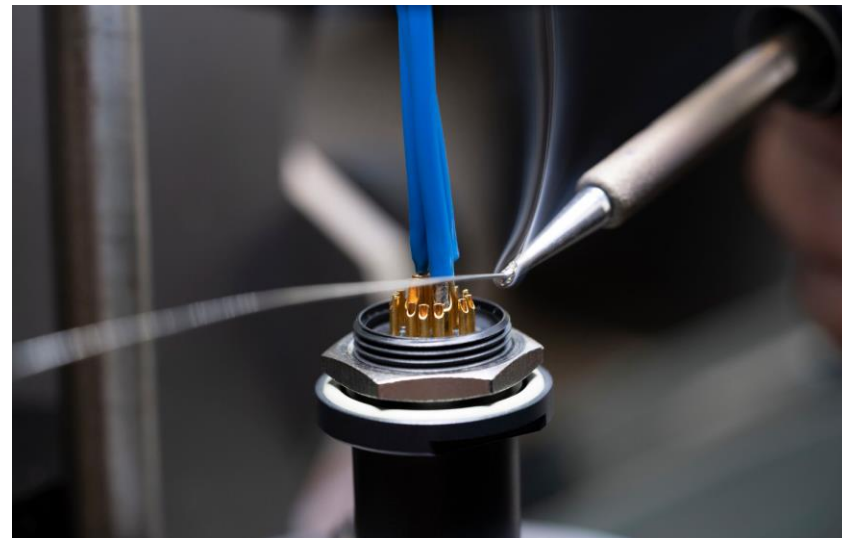

Electromechanical Components

Cabling Solutions for Networks



Building and industrial cabling, data communication

- Office fibre optic
- Office RJ45
- Industry fibre optic
- Industry RJ45
- Ethernet M12
- Industry unequipped housings
- Data centre solutions
- Assembled cables
- Accessories

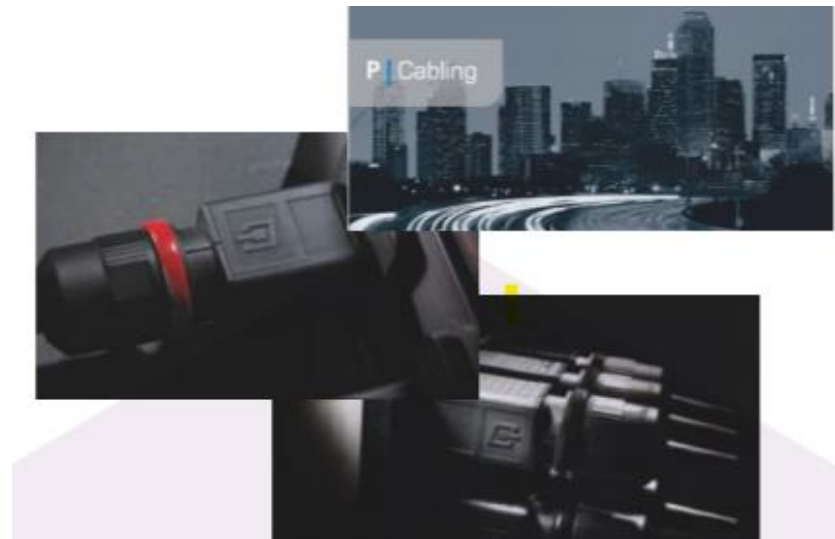

Electromechanical Components

Industrial Cables



Interconnecting wires

- Insulation: PVC, PE, TPE, Silicone, PP, PA, TPE, PUR, Glass filament, EVA, HFFR, mPPE etc.
- Temperature range: -200 to 1200°C
- Wide cross section range
- Halogen-free/flame resistant/lead free
- VDE, UL/CSA, MIL, ADR approvals
- DIN, HAR, multinorm standards
- Single, multiple, fine, flat wire
- Single, double, triple coloured
- Customised hybrid cables from 1km

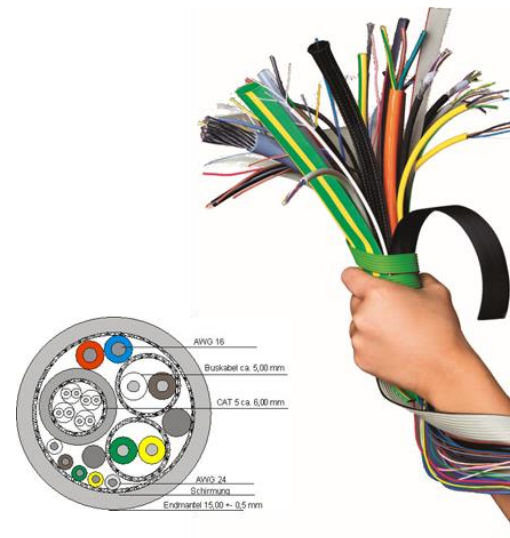

Electromechanical Components

Industrial Cables



Application in industry segments

- Engineering and automation
 - White goods production
 - Medical equipment
 - Heating system
 - Automotive
 - Agriculture
 - Lighting
 - AV
- and others

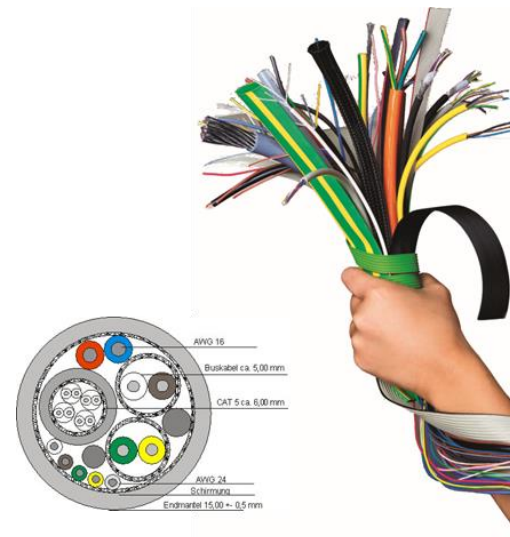

Electromechanical Components

PCB Level Connectors



- Board to Board & Cable to Board Connectors
- DC Power Jacks
- FFC Cables & Connectors
- Lighting Connectors
- Memory Card Connectors
- Modular Jacks
- Sim Card Connectors
- USB Connectors
- D-sub Connectors
- DIL, PGA, PLCC, transistor sockets
- IDC connectors & Flat ribbon cables



Electromechanical Components

Plastic Enclosures



Performance engineered enclosures

- Universal & heavy duty enclosures
- Hand held cases
- Din-Rail boxes
- Desktop and instrument cases
- 19" enclosures & subracks

Customization capabilities

- Machining: milling, drilling, cutting and countersinking etc.
- Surface coating and RFI shielding
- Printing and engraving



Electromechanical Components

Plastic Enclosures



Custom designed enclosures

- Tool FREE proces
- Rapid Lead Times
- No MOQs
- Industrial designers & CAD/CAM engineers at your disposal
- Make changes to the design quickly & easily after prototyping or after production
- Wide range of materials
- System integration



Electromechanical Components

Aluminum Heatsinks



Thermal management

- Machined extruded heatsinks
- Heatsinks and fan coolers for processors
- Lamella heatsinks
- Cooling aggregates
- Thermal interface materials

Services

- Precision Machining
- Decorative versions

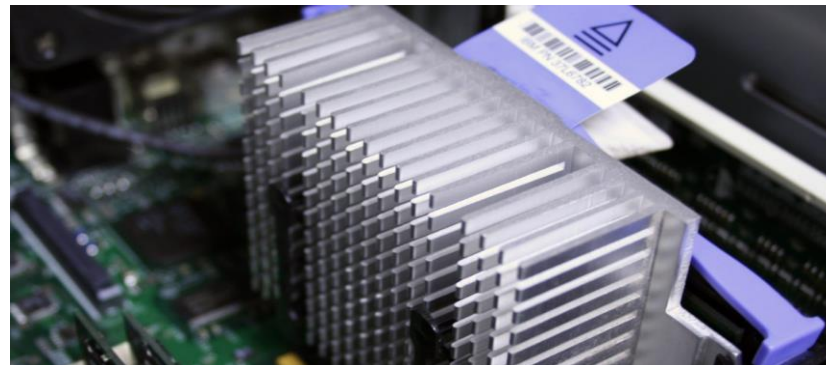

Electromechanical Components

Aluminum Cases



Cases

- Miniature aluminium cases
- Design cases
- Combination cases
- Tube cases
- Desk consoles and shell cases
- 19" System cases, subracks, Plug-in boxes

Services

- Precision Machining
- Screen printing & Laser lettering
- Powder Coating

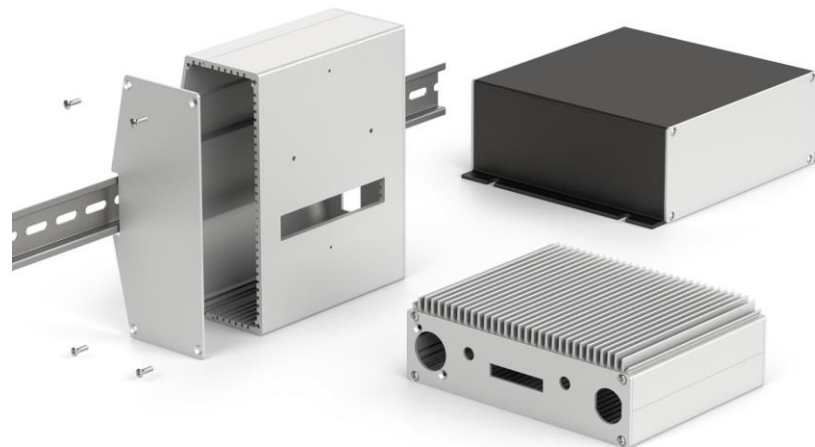

Electromechanical Components

Terminal Blocks



Spring clamp terminal blocks

- Solderable & Pluggable
- Compression-mount
- For solid wires and multi-stranded wires
- Nominal cross section of 0.08 - 2.5mm
- Centerline 2.5 - 10mm

Screw-type terminal blocks

- Solderable & Pluggable
- Single poles
- For solid wires and multi-stranded wires
- Centerline 3.5 - 10.16mm

IDC type terminal blocks

- Solderable
- Centerline 3.5 - 10.16mm





EMBEDDED



Embedded Industrial Computers



Optimised for industry

- Operating time 24h/7days
- Cost-effective & high reliability
- Wide operating temperature
- Anti-vibration & shock
- Dust resistant
- Up to 15Y product availability
- Strong metal housing & compact size
- High quality components
- Wide input voltage range
- Custom I/O interfaces
- Low power consumption



Embedded Motherboards



Motherboards

- SBC 3.5" , 4x4"
- Mini-ITX, Micro-ITX, ATX
- Mini-STX, Micro-STX
- Computer on Module
- Embedded Peripherals

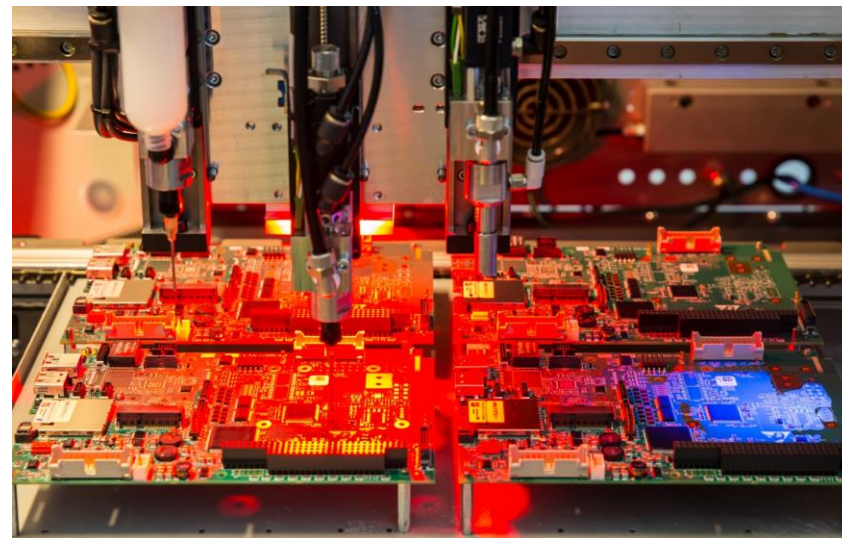

ASRock
— Industrial —

A4EON[®]
an ASUS assoc. co.

Embedded Industrial Computers



Dedicated Box PC

- Automation industry
- Digital Signage
- Machine Vision
- Robotics
- In-vehicle
- Railway



Embedded Industrial Panel Computers



Panel PC

- All-In One with IPC integrated
- Sizes from 7" to 21.5"
- Multi-functional and powerful
- Durable & professional design
- Resistive / Capacitive Touch
- IP65 front bezel
- Waterproof IP67 chassis
- LED display
- VESA / Panel Mount



Embedded Displays and projectors



Wide range of high quality monitors

- Desktop / Large format
- Protective glass
- Open-frame
- Interactive (with Touchscreen)
- Standard brightness and sun readable
- Video-wall
- Collaborative Solutions
- Projectors

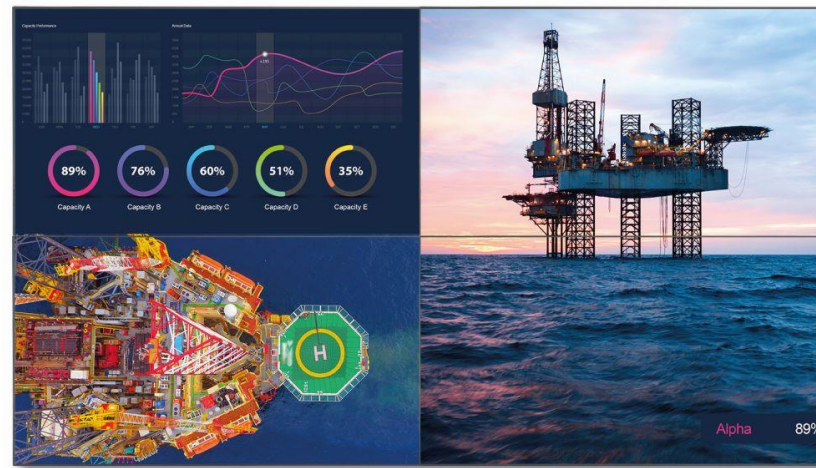

SHARP / NEC *iiyama*

LITEMAX
Sunlight Readable LCD!



TOOLS & HARNESSSES



Harness Making, Assembling & Tools

Hand Tools



Professional hand tools

- For crimping of single terminals and cable ends
- With changeable heads or dies...
- ... also used for WDT machines

- For automatic crimping of end ferrules 0.08-10.0mm²
- For automatic stripping 0.03-16.0mm²
- For cutting of cables up to 400mm²



Harness Making, Assembling & Tools

Electric Machine



Professional electric machine UP15

- Compact design and low weight
- For crimping of single terminals and cable ends
- With changeable heads or dies, used also with hand tools (CSV10, CS30 system)

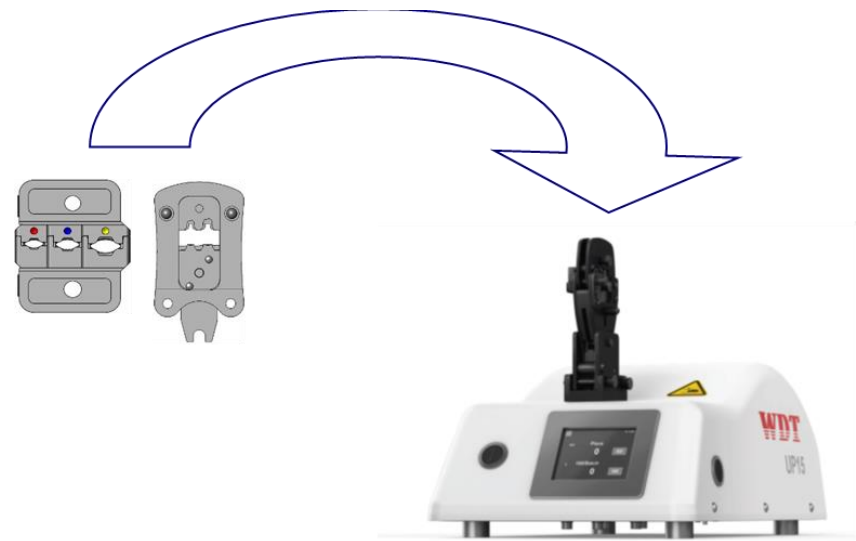

Harness Making, Assembling & Tools

Pneumatic & Hydraulic Presses



Professional presses

- With linear crimping (except UP14)
- For crimping of single terminals and cable ends up to 400 mm² (150 kN)
- With changeable heads or dies, used also with hand tools (CSV10, CS30 system)

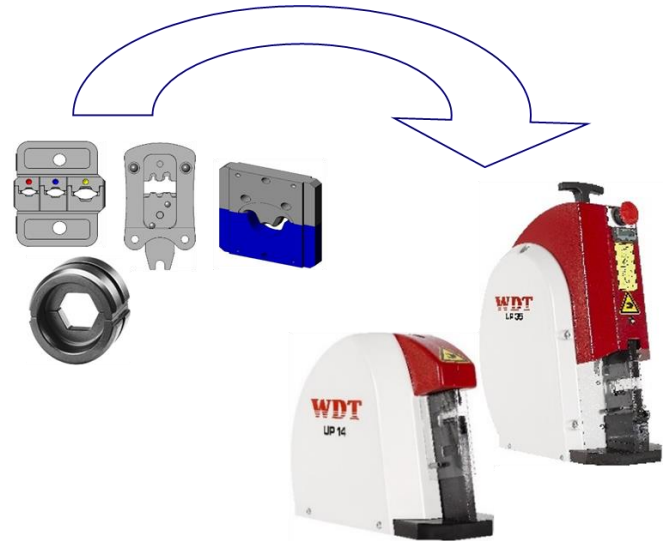

Harness Making, Assembling & Tools

Electric Presses & Applicators



Professional solution for semi automatic crimping

- For crimping of all possible reeled terminals
- Applicators used for all standard presses as well as full automatic machines (Komax, Schleuniger, etc.)
- Based on electric presses only, with crimping force 1.5 - 20 Ton
- Additional built-on equipment like CFA or stripper – crimper



ricardo barbosa
mechanical mold and tool maker

Harness Making, Assembling & Tools

In-House harness production



Customized harnesses production

- Small and mid-sized projects
- Based on all typical connectors in the full and half – automatic process
- CFA control
- Pull force measurement
- Tinning of wires (autom./manual)
- Soldering of wires to PCBs
- Assembling



THANK YOU FOR ATTENTION

WWW.MICRODIS.NET

We will be happy to support you



COMPETENCE & RELIABILITY

Bulgaria@microdis.net

Croatia@microdis.net

Czech@microdis.net

Estonia@microdis.net

France@microdis.net

Germany@microdis.net

Hungary@microdis.net

Latvia@microdis.net

Lithuania@microdis.net

Poland@microdis.net

Romania@microdis.net

Russia@microdis.net

Serbia@microdis.net

Slovakia@microdis.net

Slovenia@microdis.net

Turkey@microdis.net

Ukraine@microdis.net

EUROPE@microdis.net



Contact details: www.microdis.net